



Tilt-Turn Fixed WA8400

(rev. 01.10.13)

Tilt-Turn Fixed WA8400

Section Contents

Section Contents	1
Product Overview	2
Introduction	2
Wood Species	2
Glazing Options	2
Other Options	2
Product Parameters	3
Hardware Images	3
Exterior Elevation	4
Head Detail	5
Sill Detail	6
Left Jamb Detail	7
Right Jamb Detail	8

Product Overview

Introduction

We are proud to add the flexible and stylish Tilt-Turn W6400 (all-wood) to our product line. Popularized in Europe, the Tilt-Turn W6400 opens to the interior like a casement window when the handle is rotated 90 degrees, or tilts in slightly when the handle is rotated 180 degrees. The tilt position allows for gentle circulation during inclement weather, while the swing position allows for convenient cleaning and maximum airflow. Multiple lock points provide added stability and security, and the durable hardware allows for oversized applications. Our Tilt-Turn W6400 can be customized with screens, glazing options, and various hardware finishes.



Wood Species

Our standard wood species are the following:



The mark of
responsible forestry

- Pine
- Vertical Grain Douglas Fir
- African Mahogany

Alternative and exotic wood species are also available. See the Wood Species page in the General Info section.

Other Options

The Tilt-Turn W6400 can be purchased with additional options such as custom grille patterns, fixed exterior screen and brick or stucco exterior moulding.

Contact Pacific Architectural Millwork for additional options and customization.

Glazing Options

Standard glazing for the Tilt-Turn W6400 is 1" overall insulated glass.

Custom glazing and tinted glass are available.

Tilt-Turn Fixed WA8400

(rev. 01.10.13)

Product Parameters

Min Frame Height	16-3/8" (Based on width)
Max Frame Height	97-13/16"
Min Frame Width	16-3/8"
Max Frame Width	58-3/8"
Min Stile Width	3"
Min Jamb Depth	2-13/16"
Edge Detail	<ul style="list-style-type: none"> Interior/Exterior: Traditional or Contemporary edge detail

Hardware Images

	
London Handle (Standard)	Verona Handle
<ul style="list-style-type: none"> Silver Grey Brown Traffic White 	<ul style="list-style-type: none"> Polished Brass Antique Brass Brushed Chrome Polished Chrome Oil-Rubbed Brass Pure White Matte Black Satin Nickel Antique Nickel

Custom hardware and handles are also available.

Exterior Elevation

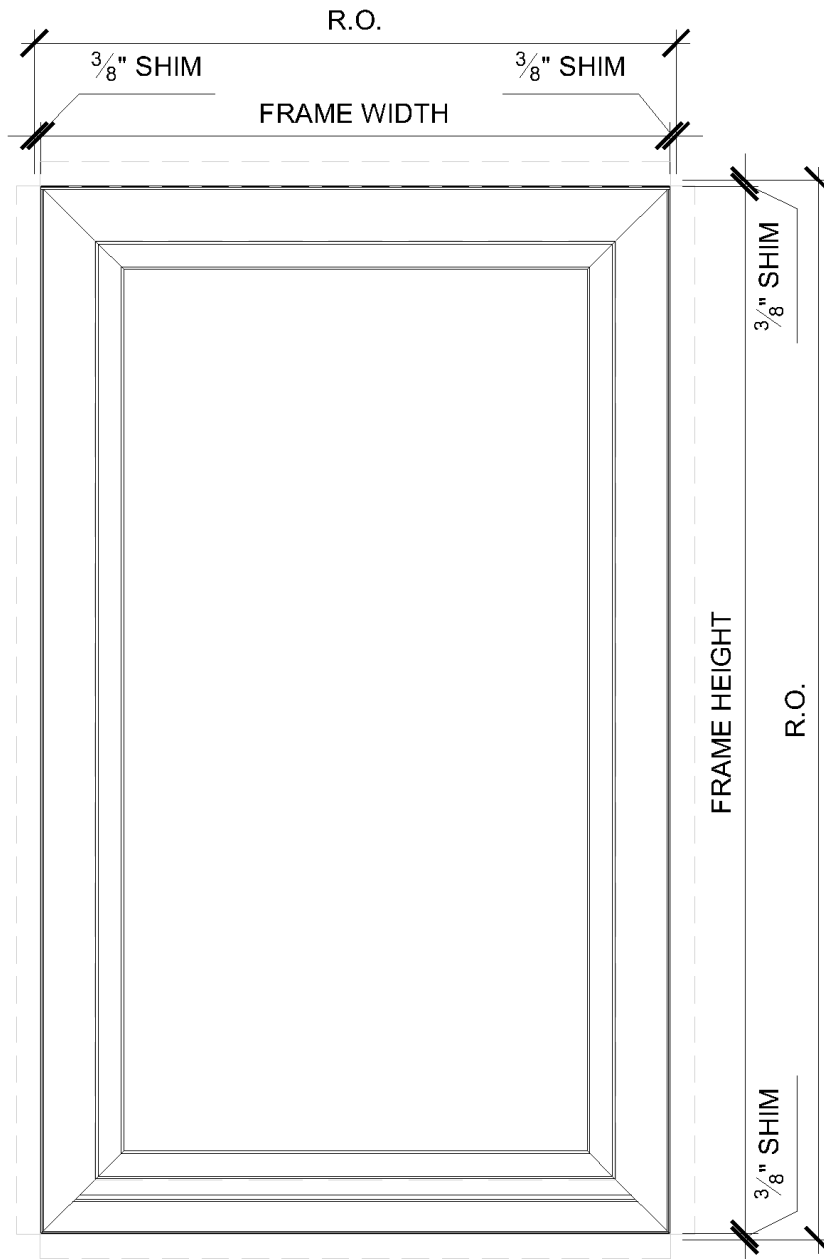

Head Detail

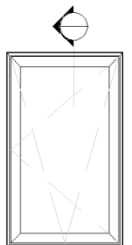
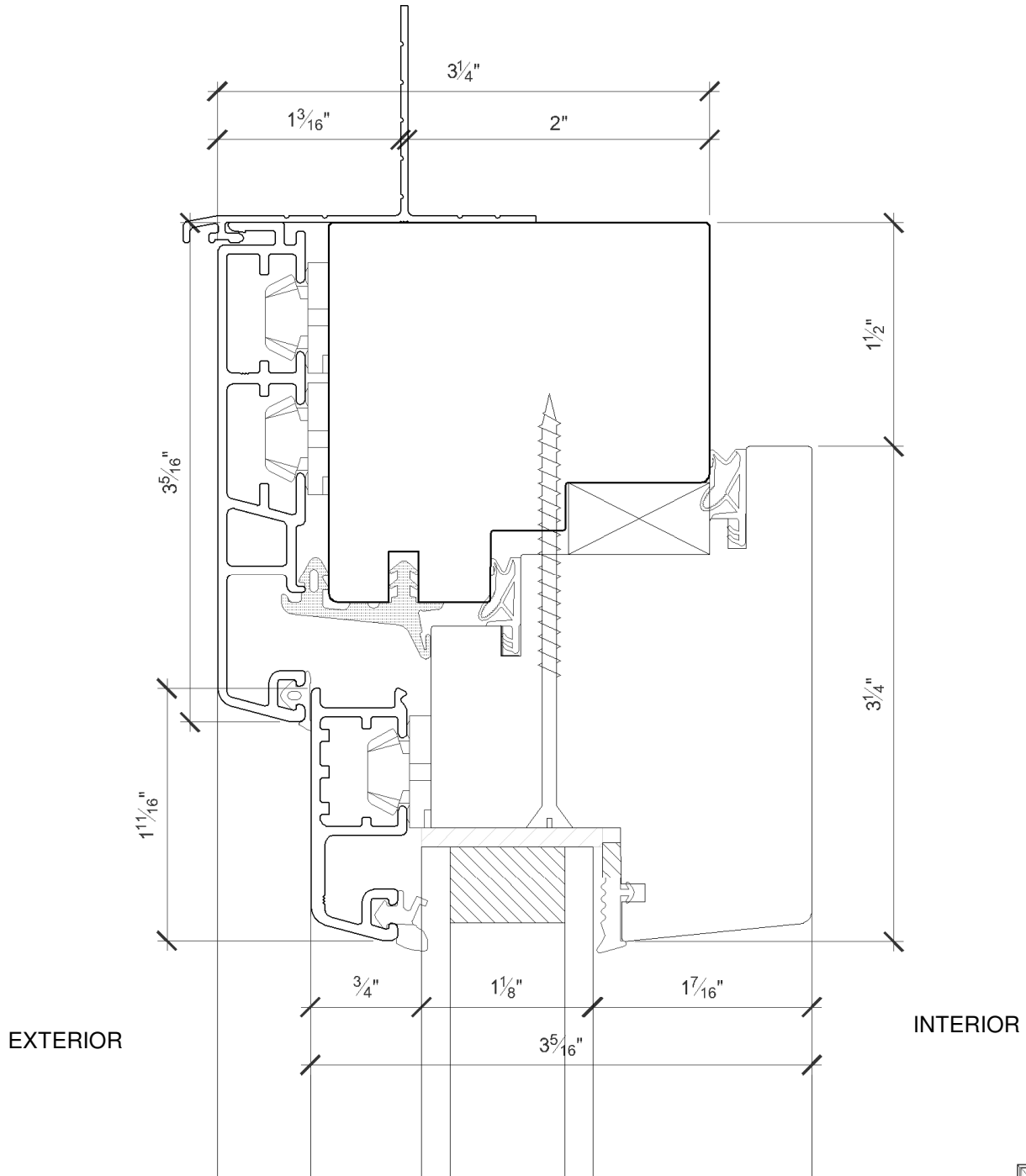

Sill Detail

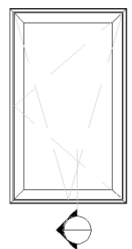
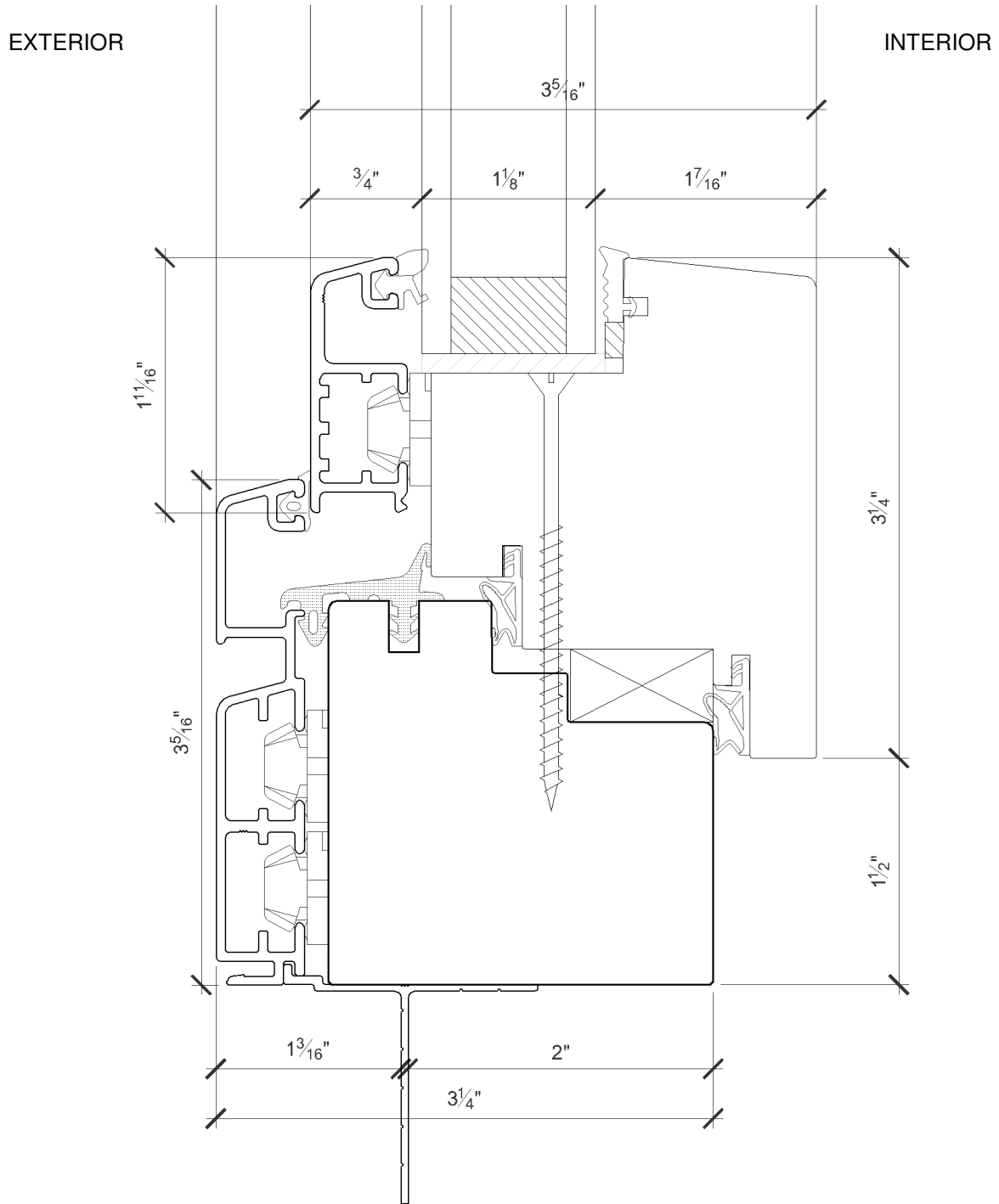

Left Jamb Detail

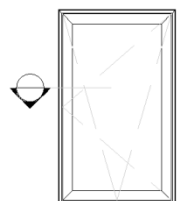
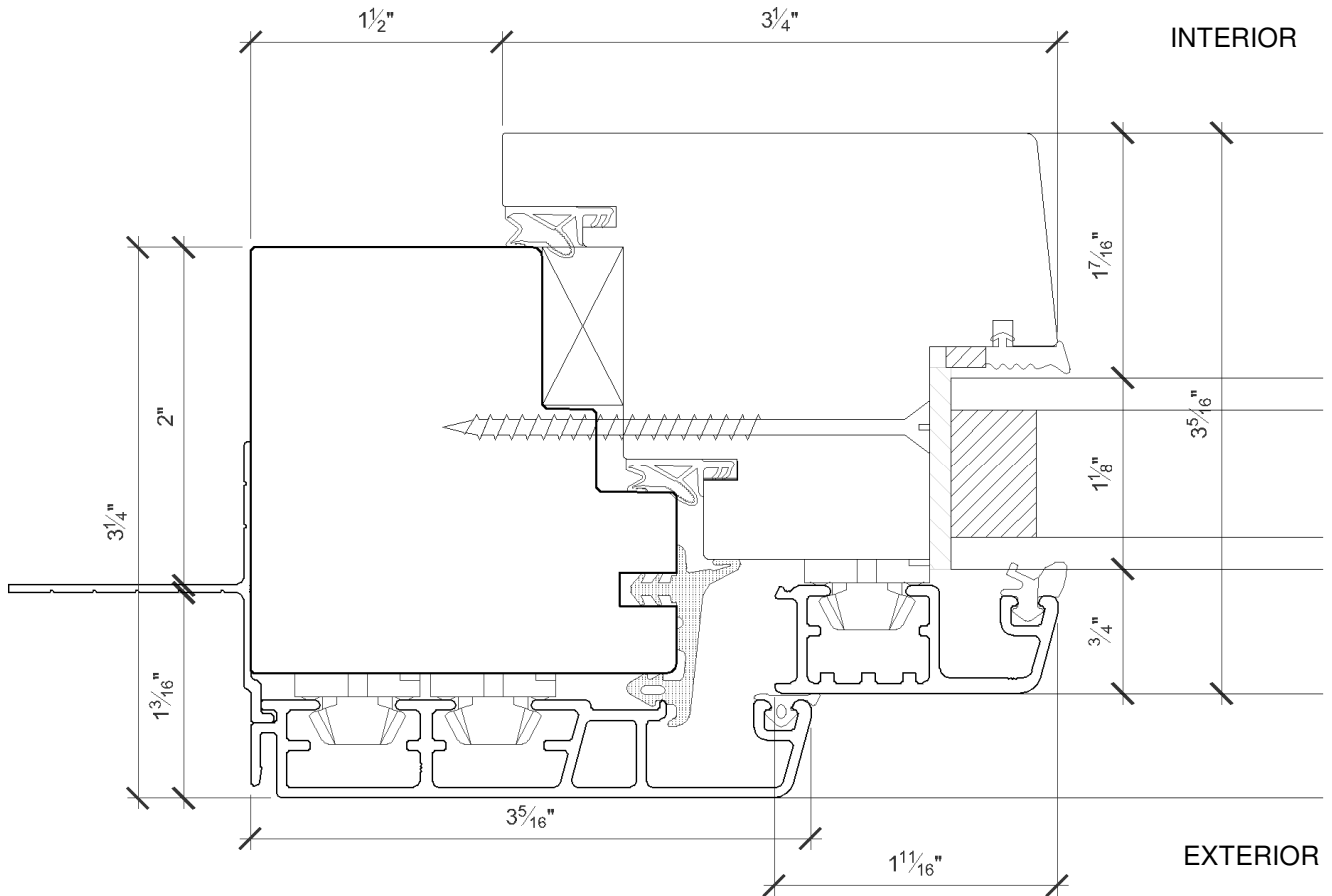

Right Jamb Detail

