



Slimline Outswing Door WA8400

(rev. 08.12.15)

Slimline Outswing Door WA8400

Section Contents

Product Overview	3
Introduction	3
Hardware Options	3
Glazing Options	3
Wood Species	3
Other Options.....	3
Hardware Images	3
Product Parameters	3
Product Photos.....	4
Single Hinged Outswing: Exterior Elevation.....	5
Double Hinged Outswing: Exterior Elevation.....	6
Outswing: Head Detail	7
Outswing: Sill Detail	8
Outswing: Sill Detail Option	9
Outswing: Jamb Detail (Strike Side)	10
Outswing: Jamb Detail (Hinge Side).....	11
Outswing: Meeting Detail	12
Fixed Outswing: Head Detail.....	13
Fixed Outswing: Sill Detail.....	14
Fixed Outswing: Sill Detail Option.....	15
Fixed Outswing: Typical Jamb Detail.....	16
Fixed Outswing: Meeting Detail.....	17
Contemporary SDL Detail.....	18

Product Overview



Introduction

The Slimline Outswing Door WA8400 combines the clean, minimal sight lines of all-aluminum or steel doors with the natural beauty and superior thermal performance of wood. This contemporary stile-and-rail door is clad on the exterior with durable, heavy-gauge extruded aluminum and finished with a custom color-matched Kynar paint, for reduced maintenance and maximum protection against fading and corrosion. Each door is pre-hung and precision-built by master craftsmen, resulting in premium quality and beauty you can see and feel.

The Slimline Door is available in both single and double door configurations. For inswing operation, you can choose either the Standard or Euro version (see relevant product ADMs for more details).

Hardware Options

Doors are pre-hung on brass hinges, in either Oil-Rubbed Bronze or Satin Nickel finish.

Due to the narrow stiles, handle and escutcheon options are limited. Contact Pacific Architectural Millwork for more details.

Glazing Options

Standard glazing for the optional glass panel uses 1 1/8" overall tempered insulated glass. Custom glazing, tinted glass, and clad panels are also available.

Due to the narrow stiles and rails, the interior wood edge detail and exterior clad profile is Contemporary only.

Wood Species

Our standard wood species are the following:





- Pine
- Vertical Grain Douglas Fir
- African Mahogany

Ask for FSC®-certified products. Alternative and exotic wood species are also available.

Other Options

Contact Pacific Architectural Millwork for additional options and customization.

Hardware Images

	
London Handle (Standard)	Verona Handle (Optional)
<ul style="list-style-type: none"> • Silver • Grey Brown • Traffic White 	<ul style="list-style-type: none"> • Resista Brass • Oil-Rubbed Brass • Satin Nickel

Product Parameters

Max Frame Height	120"
Max Frame Width	43 3/4"
Min Frame Height	66"
Min Frame Width	20"
Panel Thickness	3-5/16"
Stile Width	3"
Min Jamb Depth	4-9/16"
Edge Detail	<ul style="list-style-type: none"> • Exterior: Contemporary • Interior: Contemporary* <p>*Adding Contemporary or Traditional grids to the window will require Contemporary edge detail</p>

Product Photos



Single Hinged Outswing: Exterior Elevation

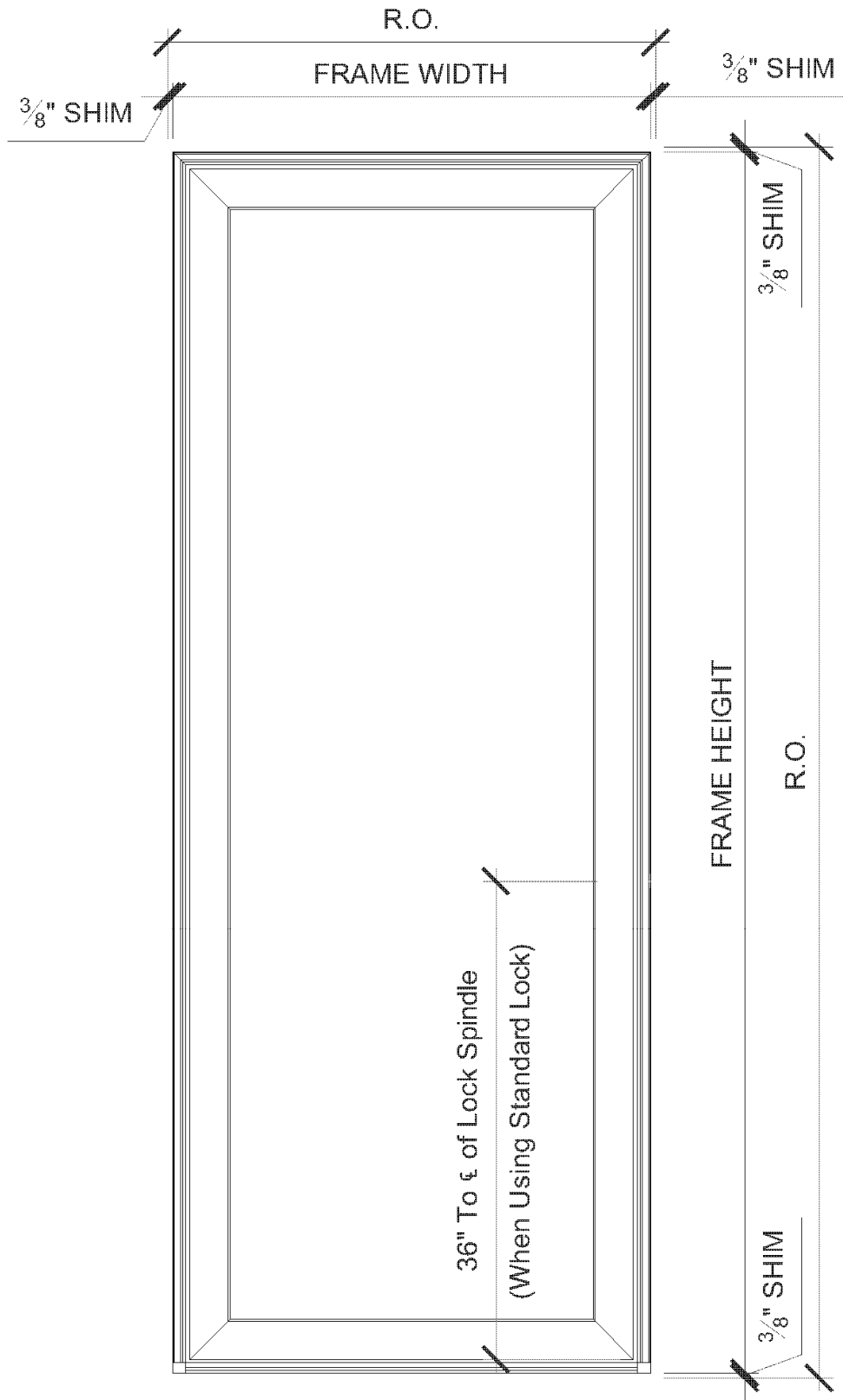

Double Hinged Outswing: Exterior Elevation

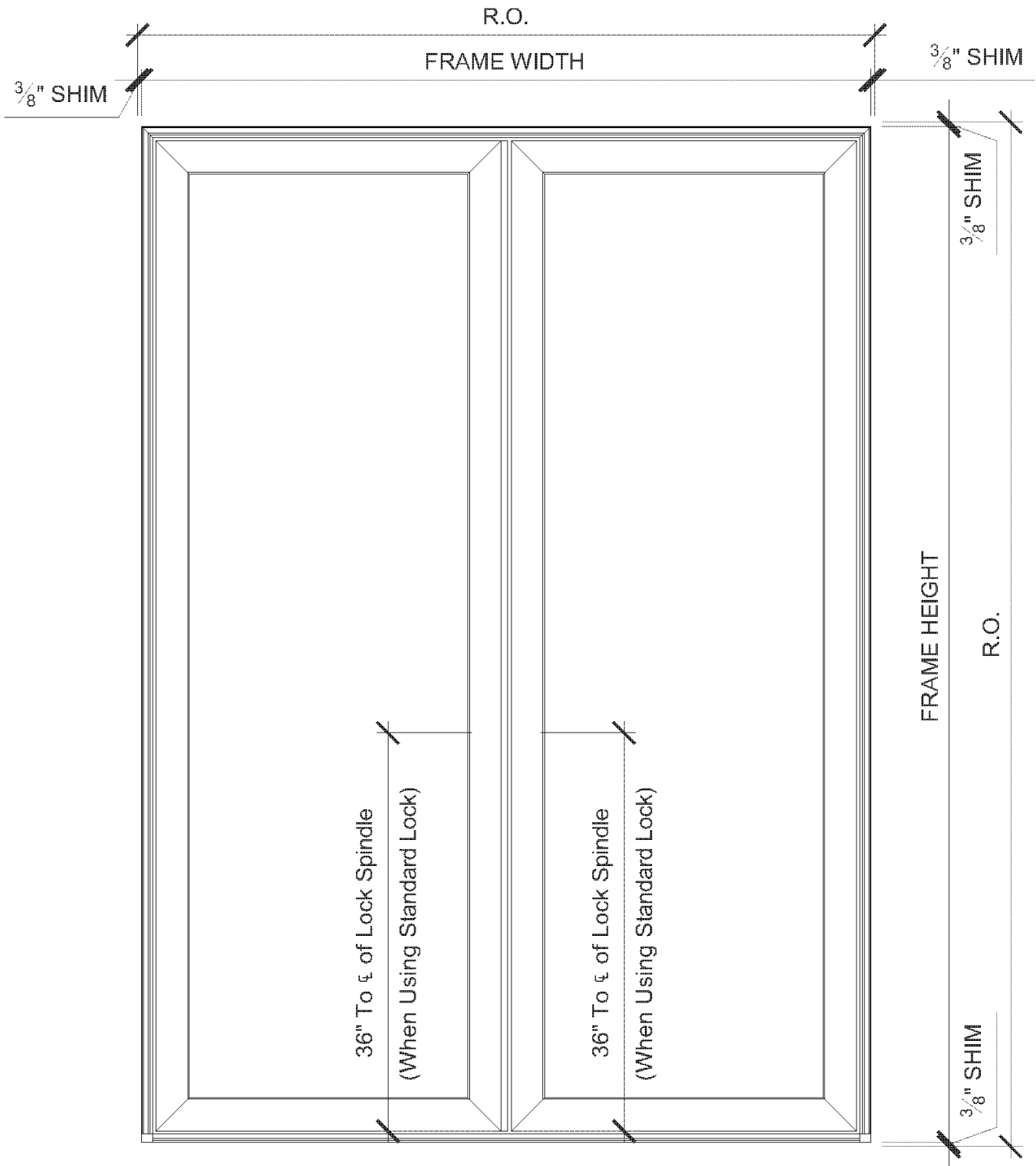

Outswing: Head Detail

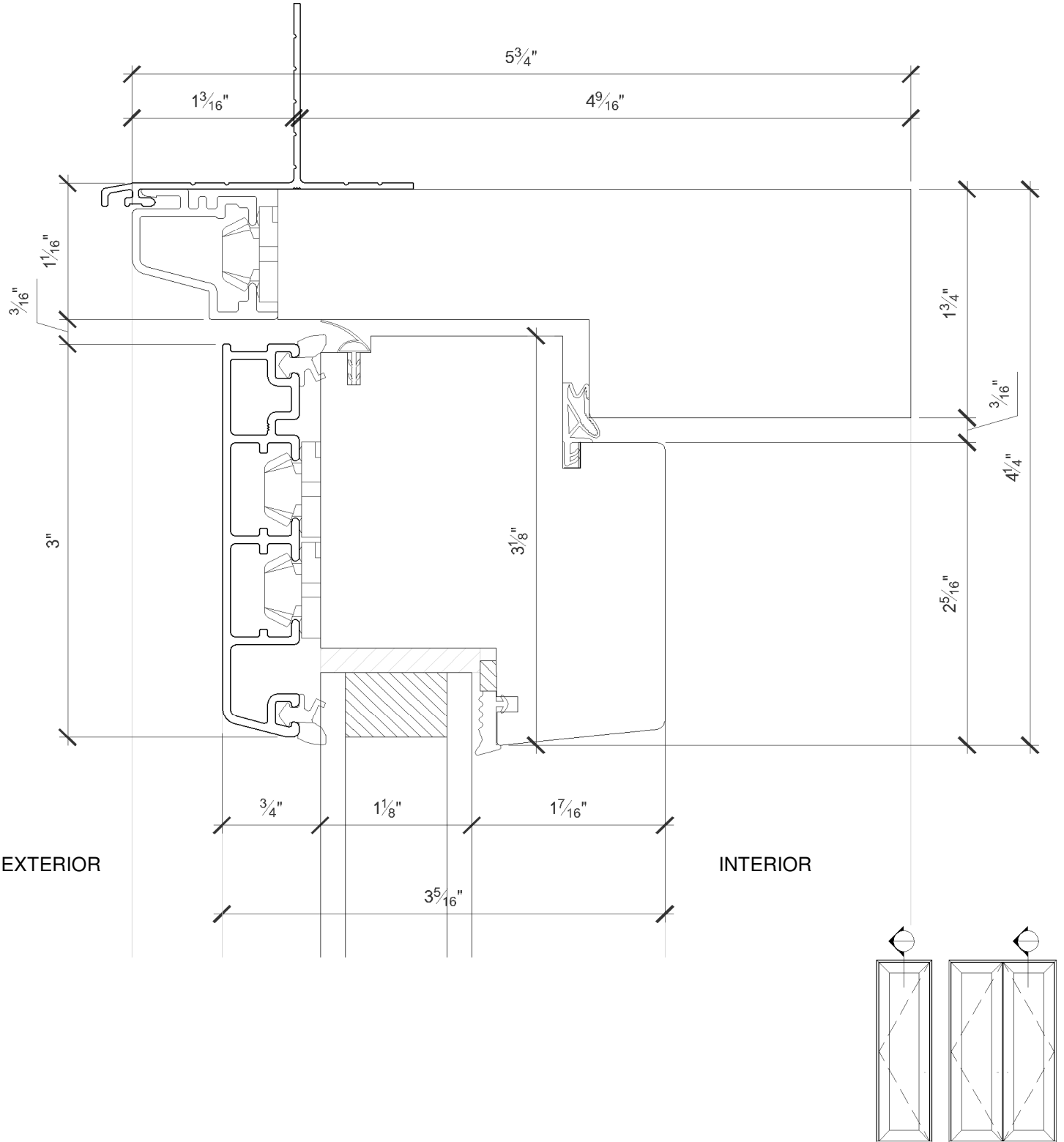

Outswing: Sill Detail

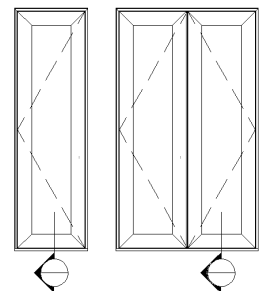
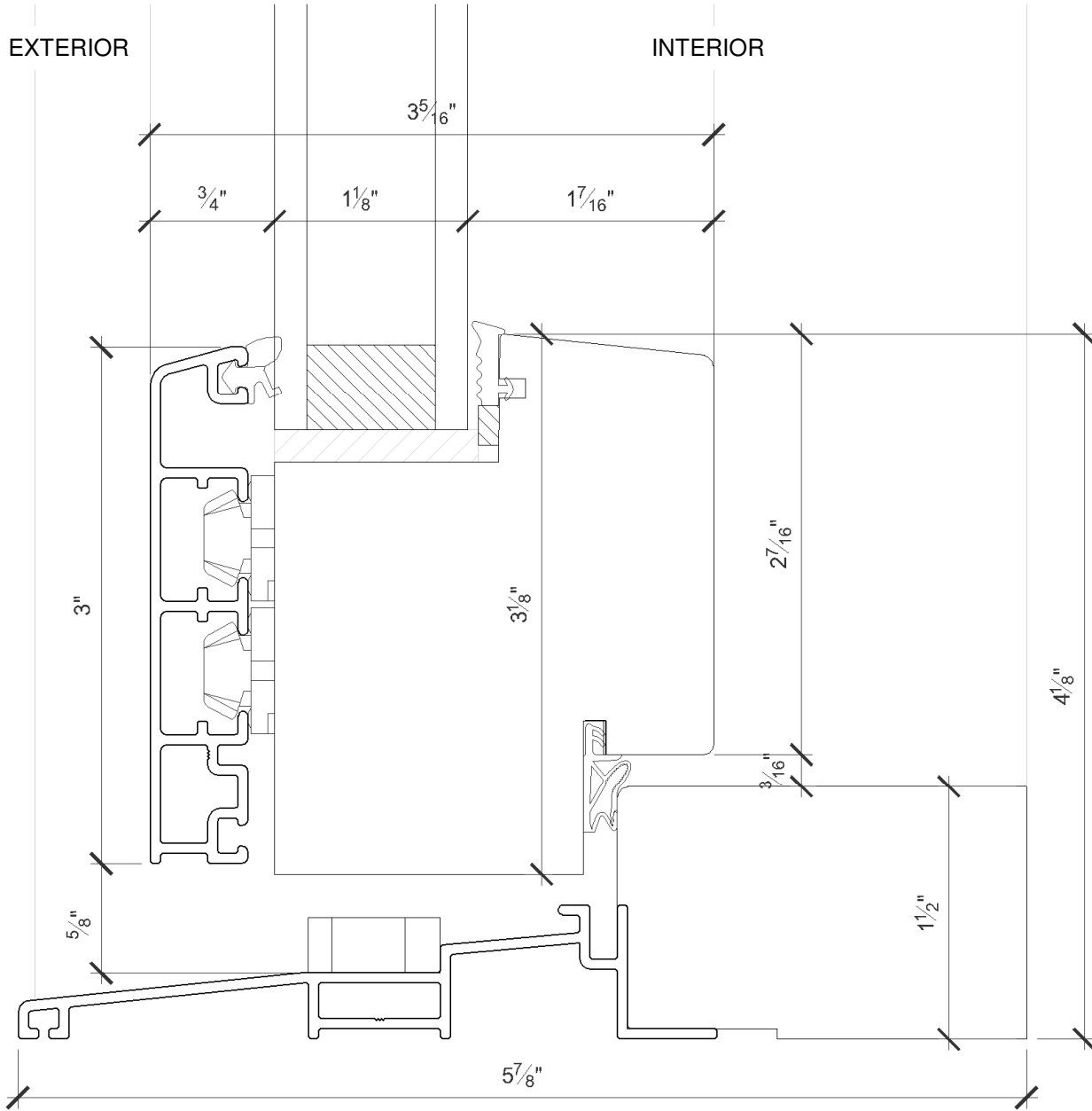

Outswing: Sill Detail Option

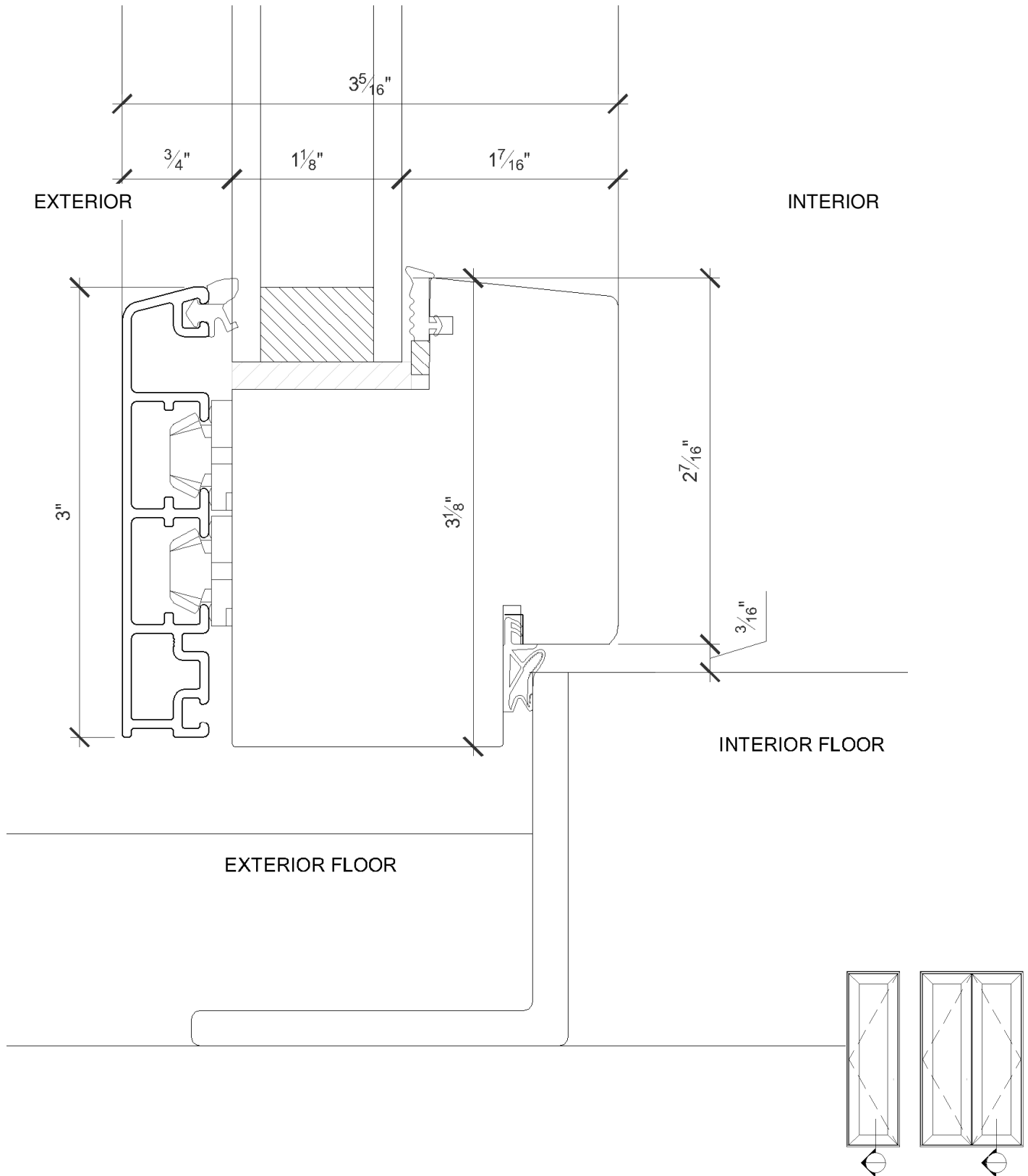

Outswing: Jamb Detail (Strike Side)

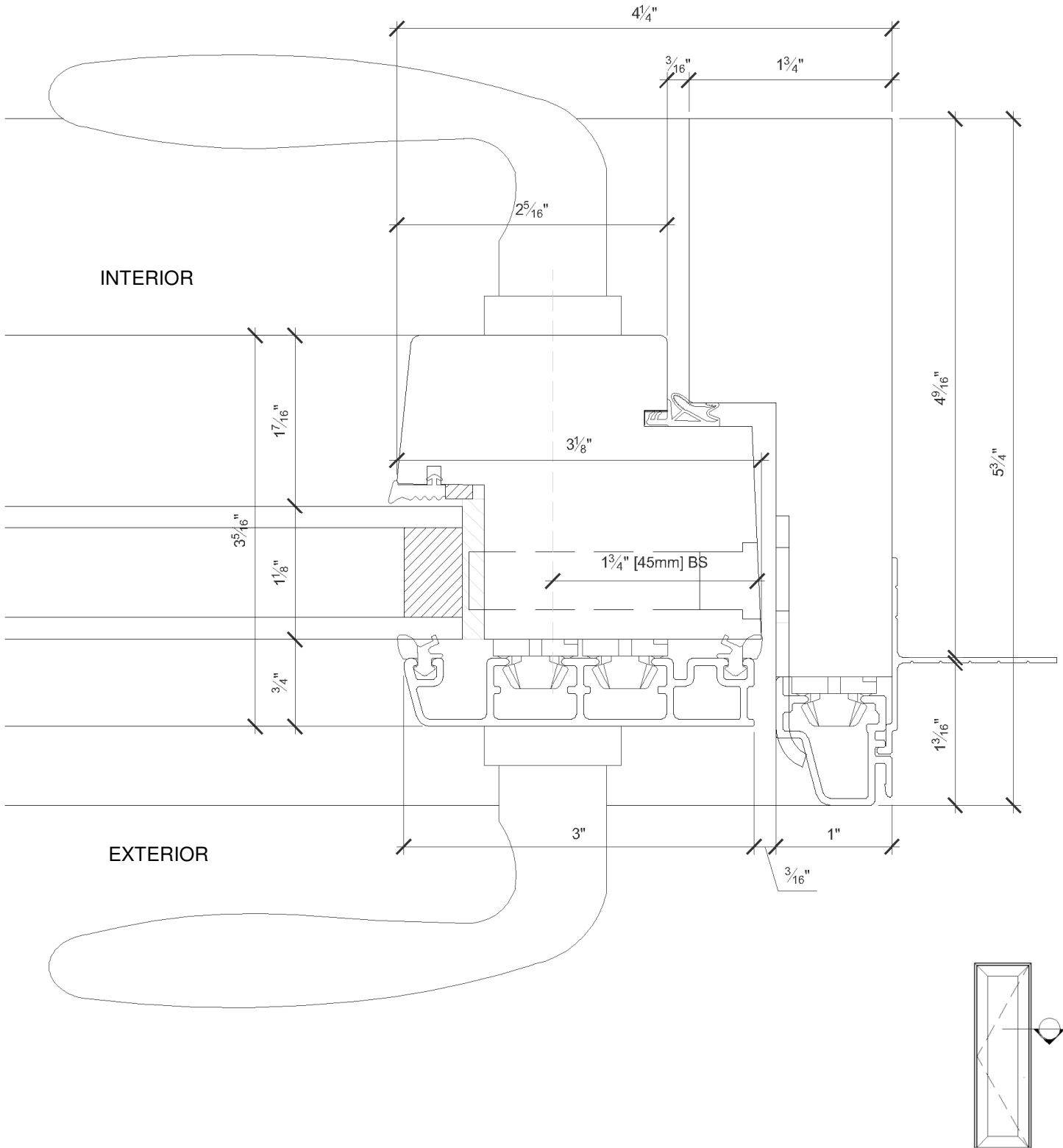

Outswing: Jamb Detail (Hinge Side)

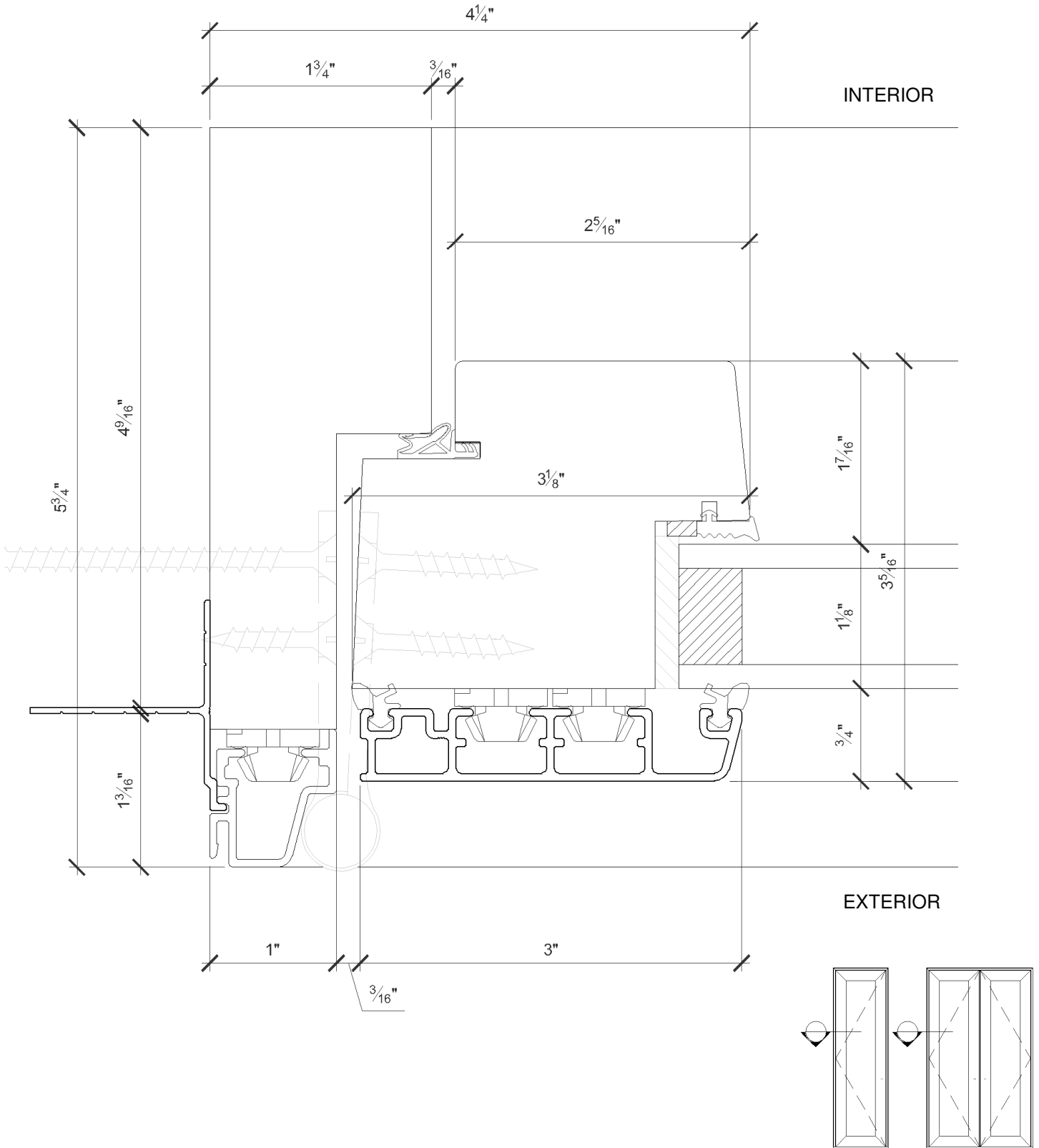

Outswing: Meeting Detail

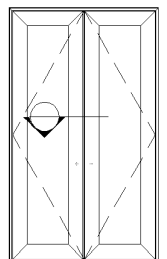
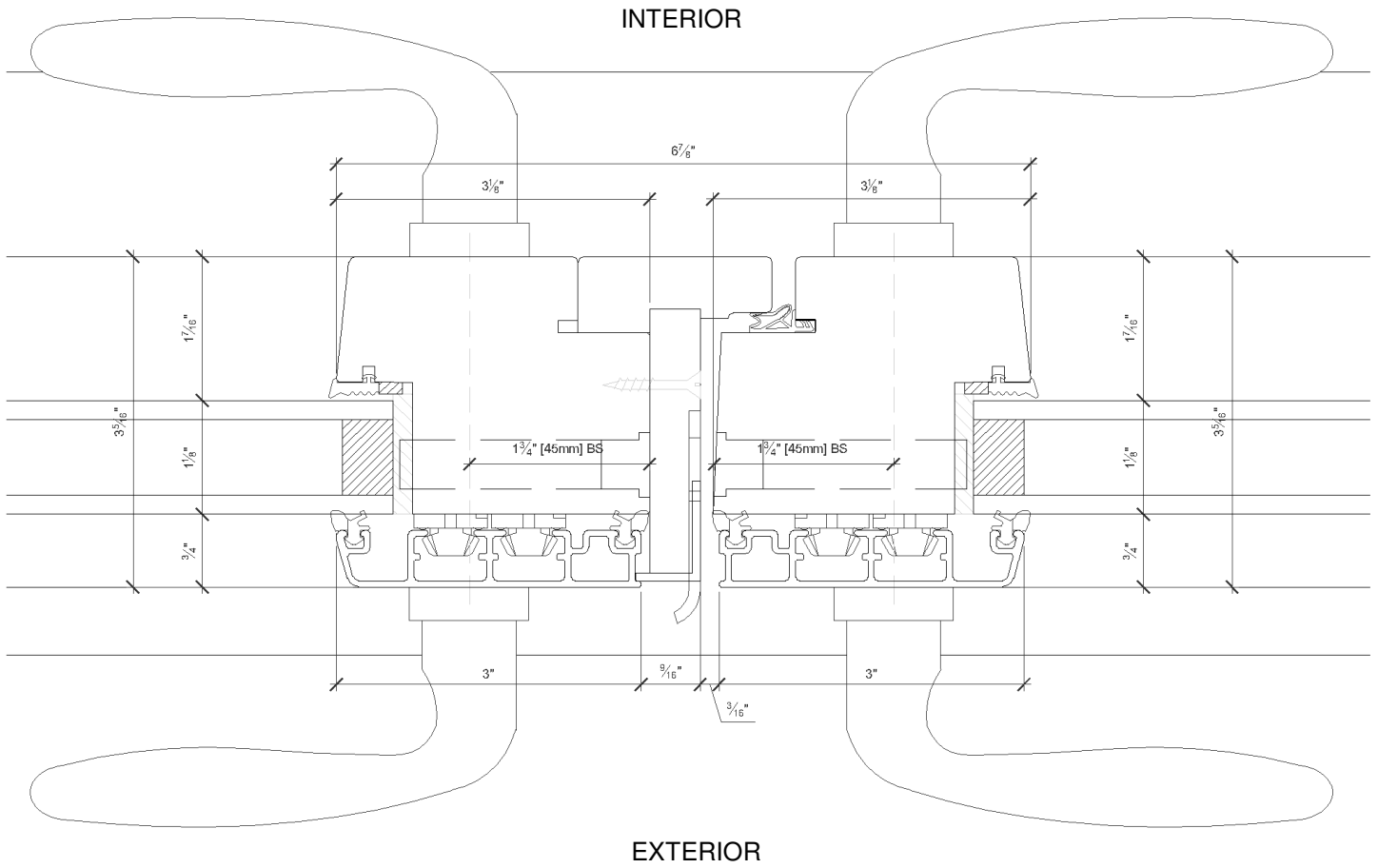

Fixed Outswing: Head Detail

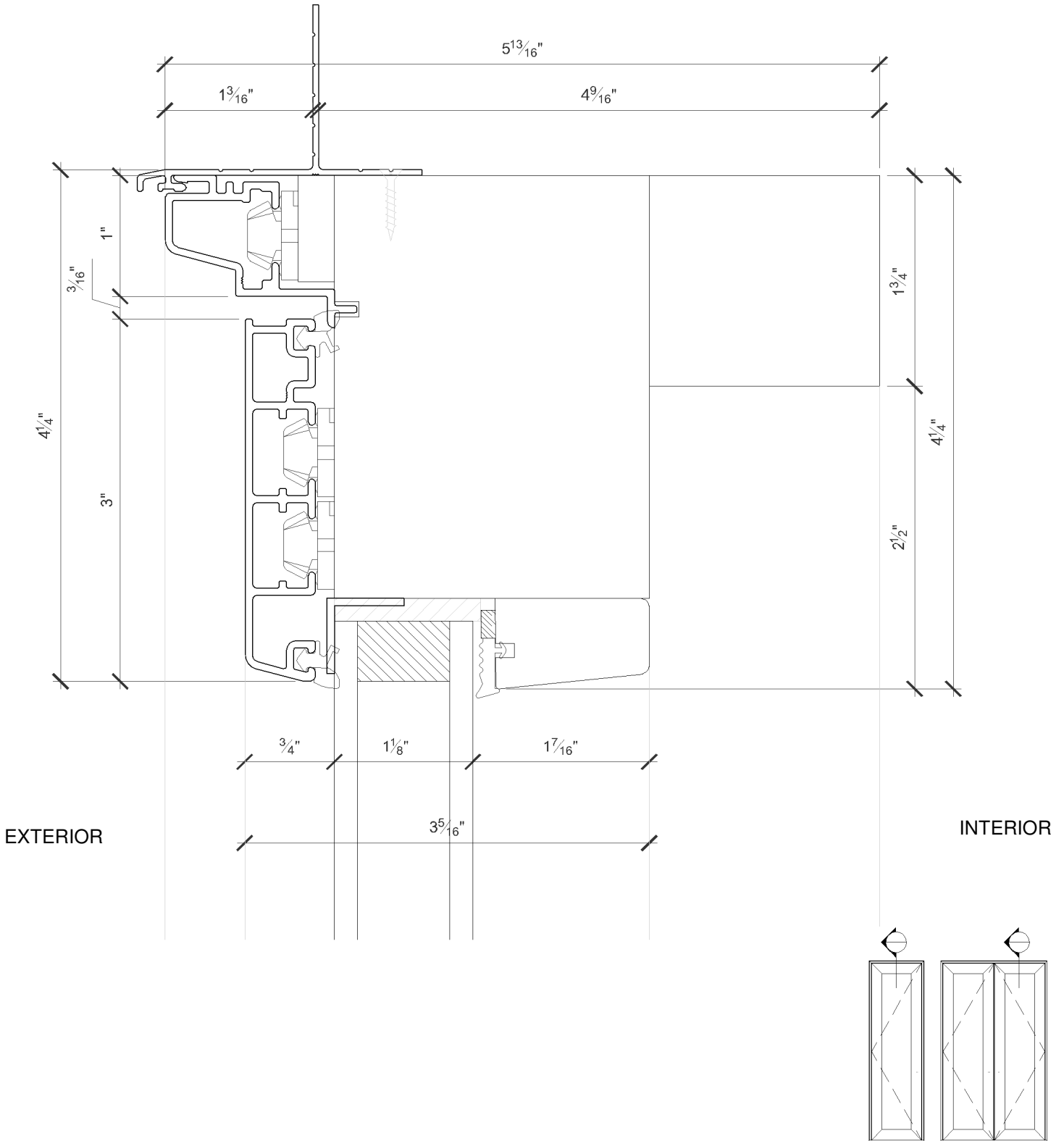

Fixed Outswing: Sill Detail

EXTERIOR

INTERIOR

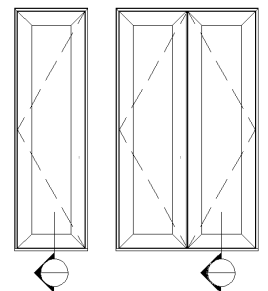
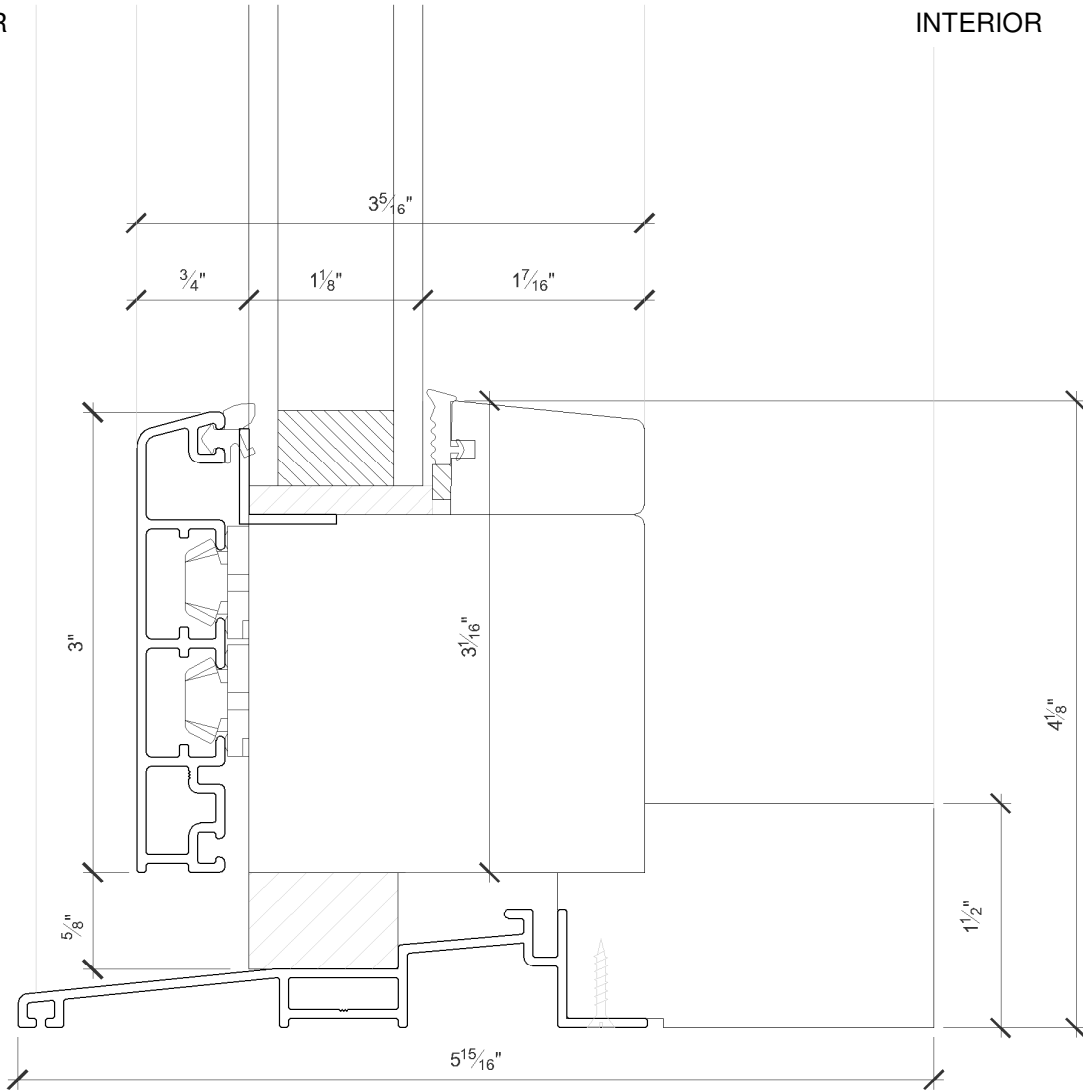

Fixed Outswing: Sill Detail Option

EXTERIOR

INTERIOR

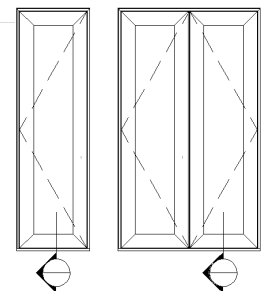
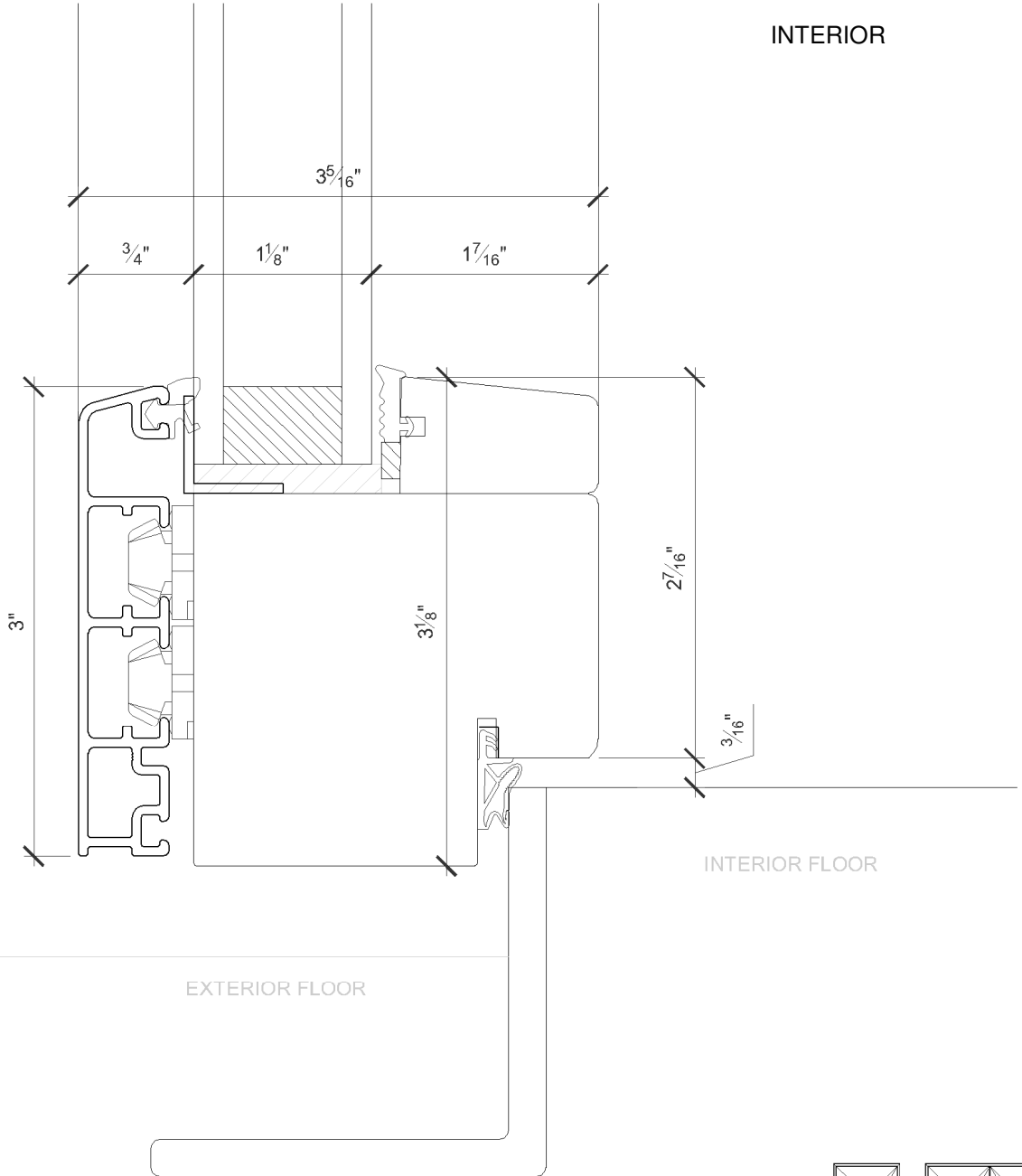

Fixed Outswing: Typical Jamb Detail

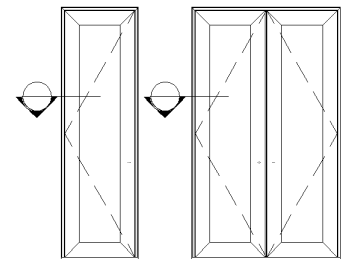
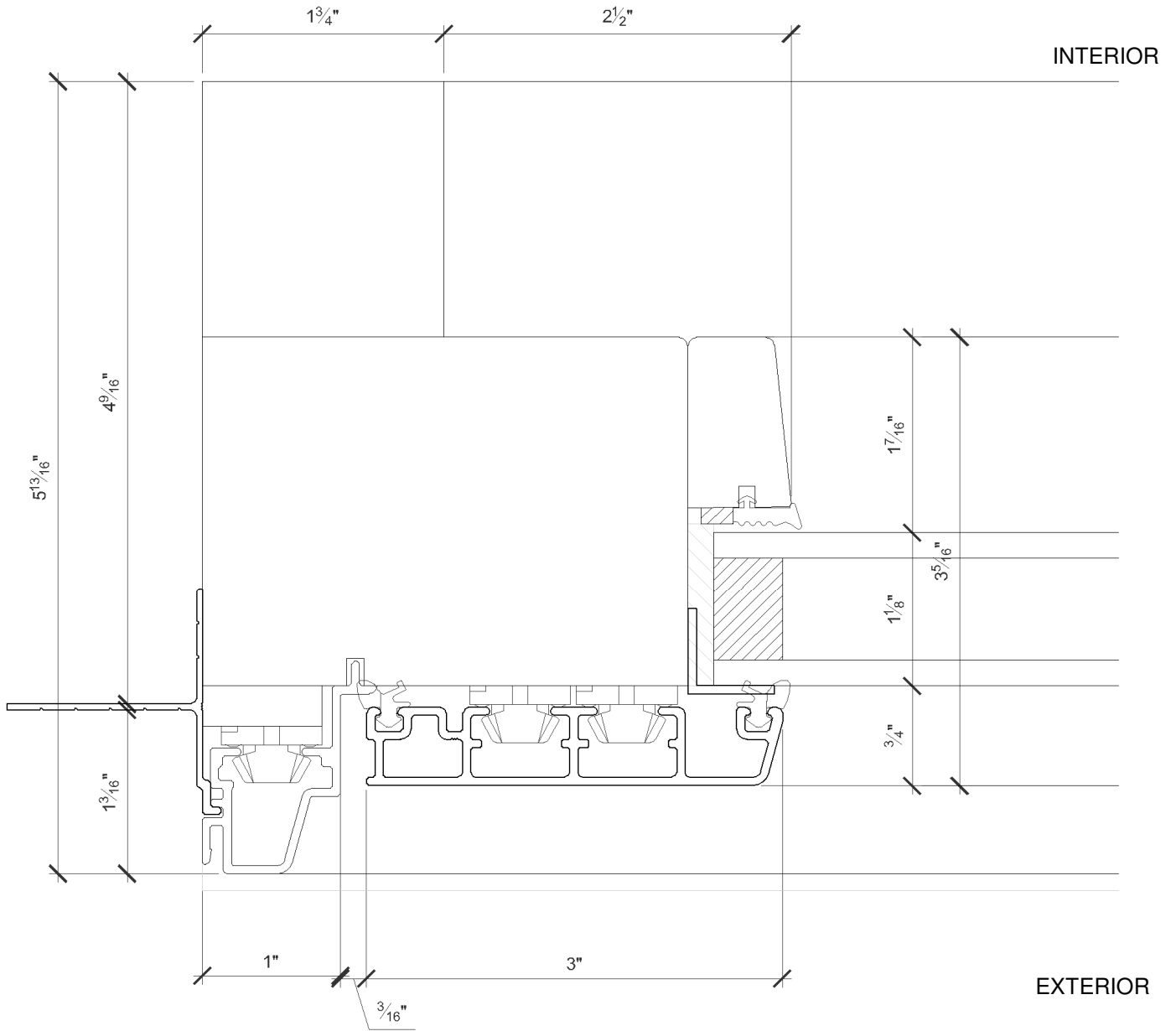

Fixed Outswing: Meeting Detail

INTERIOR

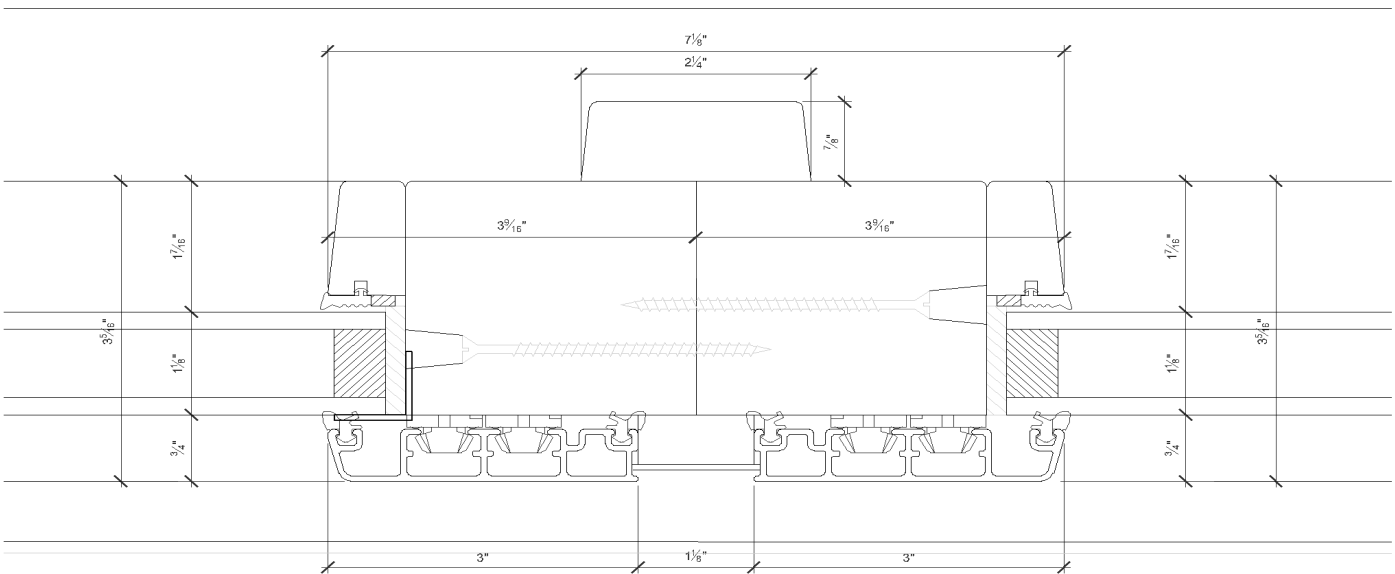

EXTERIOR

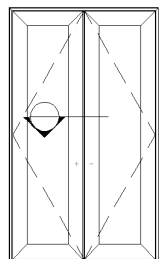

Contemporary SDL Detail

